

H05VV-F 3X1.0mm²

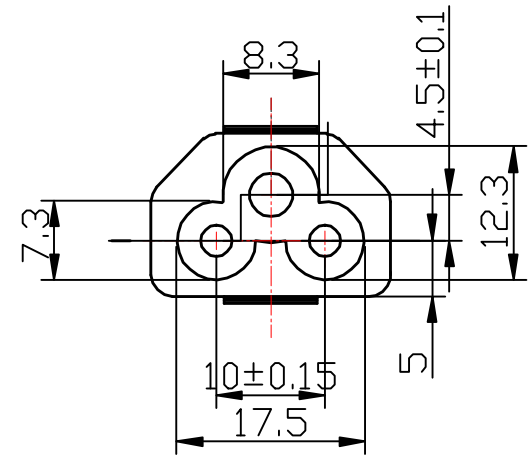

④	TAG	1PCS	DELTACO TAG
③	IEC C5	1PCS	BLACK PVC
②	BS1363	1PCS	BLACK PVC
①	CABLE	1PCS	H05VV-F 3*1.0mm ² BLACK PVC JACKET OD:6.7±0.2mm
NO.	PARTS NAME	Q'TY	SPECIFICATION

APPROVED	CHECKED	DRAWN	ITEM NO.	DEL-109F-UK
			DRAW NO.	
			UNIT	mm
			SCALE	NONE

DESCRIPTION:
BS1363-----IEC C5
H05VV-F 3*1.0mm²
3m

